

SWITCH MODE DC POWER SUPPLY



SAMLEX AMERICA

REGULATED DC POWER SUPPLY

**MODELS : SEC-1212
SEC-1223**

INSTALLATION & OPERATING MANUAL

TABLE OF CONTENTS

Topic	Page
Important safety instructions	1
Description and features	2
Input voltage conversion	2
Connection and operation	3
Cooling and fan control	3
Battery charging and back up	4
Trouble shooting	4,5,6
Specifications	7
Warranty information	8
Notes :	9

CAUTION !



RISK OF ELECTRIC SHOCK
DO NOT OPEN



WARNING—TO REDUCE THE RISK OF FIRE OR ELECTRIC SHOCK, DO NOT EXPOSE THIS APPLIANCE TO RAIN OR MOISTURE. THERE ARE NO USER SERVICEABLE PARTS INSIDE—REFER TO QUALIFIED SERVICE PERSONNEL.

IMPORTANT SAFETY INSTRUCTIONS

Please read before using your power supply.

- 1.) It is recommended that you return your power supply to a qualified Samlex dealer for any service or repair. Incorrect assembly may result in electric shock or fire.
- 2.) To reduce the risk of electric shock, unplug power supply from outlet before attempting any maintenance or cleaning. Turning off controls will not reduce this risk.
- 3.) An extension cord should not be used unless absolutely necessary. **If an extension cord must be used make sure that the pins on the plug are the same number, size and shape as those of the original power supply plug.**
- 4.) Place the unit in an area that will allow air to flow freely around the unit. DO NOT block or obstruct vent openings on the side/bottom of the unit.
- 5.) Keep the unit away from moisture and water.
- 6.) **NEVER OPERATE THE UNITS IN PARALLEL**

WARNING

Your power supply should be grounded to reduce the risk of electric shock. The power supply is equipped with grounding conductor and grounding plug.

The cord must be plugged into an outlet that is properly installed and grounded in accordance with all local codes and ordinances. Never alter the AC cord or plug provided. If the cord will not fit the outlet, have a proper outlet installed by qualified electrician. Improper connection can result in risk of electric shock.

DO NOT USE THE POWER SUPPLY FOR DIRECT CHARGING OF BATTERY OR DIRECT CONNECTION TO A BATTERY FOR BATTERY BACK-UP. (Please read the section on Battery Back-up).

DESCRIPTION

SEC-1212 / SEC-1223 are switched mode power supplies which convert 120 VAC, 60 HZ. or 240 VAC, 50 HZ to regulated 13.8 VDC based on pulse width modulation (PWM) control. (NOTE : These units are factory pre-set for 120 VAC, 60 HZ. input . For conversion to 240 VAC, 50 HZ. , please see instructions below).

FEATURES

- BASED ON SWITCHED MODE TECHNOLOGY AND PWM CONTROL
- COMPACT AND LIGHTWEIGHT
- HIGH EFFICIENCY AND LESS HEAT DISSIPATION
- PROTECTED AGAINST SHORT CIRCUIT, OVER CURRENT AND OVER VOLTAGE (THROUGH PWM CONTROLLER)
- SEC-1212 IS CONVECTION COOLED. SEC-1223 HAS FORCED AIR COOLING AND OVER TEMPERATURE SHUT DOWN
- UL LISTED AND APPROVED
- COMPLIES WITH CLASS "B", PART 15 OF F.C.C. RULES FOR RADIATED AND CONDUCTED NOISES

INPUT VOLTAGE CONVERSION FROM 120 VAC TO 240 VAC

WARNING ! TO REDUCE THE RISK OF ELECTRICAL SHOCK, IT IS RECOMMENDED THAT THE FOLLOWING SERVICE BE PERFORMED BY A QUALIFIED SERVICE TECHNICIAN

1. Unplug the power supply form the AC outlet
2. Remove the top cover
3. **SEC-1212** : Points "D" and "E" on the printed circuit board are connected with a flexible wire jumper for 120 VAC input. Disconnect the jumper at point "D" by pulling the female quick connect upwards. Tape the end of this quick connect with insulation tape. Change the fuse to 2A (see fuse rating at page 7)

SEC-1223 : Points "C" and "E" on the printed circuit board are connected with a flexible wire jumper for 120 VAC input. Disconnect the jumper at point "C" by pulling the female quick connect upwards. Tape the end of this quick connect with insulation tape. Change the fuse to 4A (see fuse rating at page 7)

4. Replace the top cover.

CONNECTION AND OPERATION

WARNING ! Before plugging the unit to the AC outlet, please check that your local supply voltage is 120 VAC. If your local supply voltage is 240 VAC, change the internal voltage selection to 240 VAC (SEE “ **INPUT VOLTAGE CONVERSION FROM 120 VAC TO 240 VAC**” IN THE PREVIOUS SECTION)

Ensure that the power supply's ON/OFF switch is off and it is unplugged from the AC outlet.. Switch off your 12 V DC device and connect it's positive and negative to the RED (Positive) and WHITE (Negative) terminals respectively. Ensure that the connections are secure and tight. Plug the power supply into the AC outlet. Press the ON/Off switch of the power supply to ON and observe that the neon indicator in the switch illuminates. If the indicator fails to light , recheck the connection, AC outlet and the fuse inside the power supply.

Your 12 V DC device may now be switched on.

COOLING AND FAN CONTROL / THERMAL SHUT DOWN (SEC-1223)

SEC-1212 is cooled by convection.

PLACE THE UNIT IN A WELL VENTILATED OPEN AND COOL AREA.
DO NOT BLOCK THE VENTILATION OPENINGS ON THE SIDES

SEC-1223 is cooled by convection and forced air. A temperature controlled fan has been provided to improve cooling at higher loads. The fan is controlled by a sensor mounted on the power transformer. **THE FAN WILL BE OFF AT LOWER LOADS.** It will come on only when the temperature of the power transformer is above 70°C due to higher loads. In case the fan fails or the air flow is blocked, a second temperature sensor mounted on the power transformer will activate over temperature shut down at 100°C. The output voltage will be automatically resumed once the unit cools down.

PLACE THE UNIT IN A WELL VENTILATED OPEN AND COOL AREA.
DO NOT BLOCK THE OPENINGS AT THE FAN SUCTION ON THE BOTTOM AND THE DISCHARGE OPENINGS ON THE SIDES .

BATTERY CHARGING AND BATTERY BACK-UP



WARNING ! THESE UNITS ARE POWER SUPPLIES AND NOT BATTERY CHARGERS. DO NOT CONNECT THESE UNITS DIRECTLY TO A BATTERY

These units should **NOT BE DIRECTLY CONNECTED TO A BATTERY** for charging or for battery back-up. Battery charging and battery back-up may be undertaken only when the battery is connected through suitable external isolating diodes and charge limiting resistor. The isolating diode will ensure that the battery does not back power the power supply. When a battery is deeply discharged, it will initially draw a very large charging current and thus, will force the power supply into current limit mode for prolonged periods. This is harmful for the power supply. The charge limiting resistor will limit the charging current, thereby, ensuring that the maximum charging current is well below the current limit value of the power supply.

WE OFFER OPTIONAL BATTERY BACK-UP AND CHARGING MODULE . PLEASE CONTACT OUR CUSTOMER SERVICE

TROUBLESHOOTING - GENERAL

PROBLEM : Power ON/OFF switch does not illuminate when turned on.

PROBABLE CAUSE

SUGGESTED REMEDY

No power in the AC outlet

Check there is power in the outlet.

AC side fuse inside the power supply is blown

Replace the fuse inside the unit. See fuse ratings at page 7

PROBLEM : AC side fuse blows as soon as power is turned on.

PROBABLE CAUSE

SUGGESTED REMEDY

Unit is defective

Call technical support.

PROBLEM : The output voltage is 0 V or very low

PROBABLE CAUSE

SUGGESTED REMEDY

Input voltage is very low

Check that the input voltage is 120VAC or 240 VAC as selected

The input voltage has been converted to 240 VAC but the unit has been plugged into 120 VAC outlet

Power the unit from the proper AC voltage

The unit is in current limit condition due to overload caused by large reactive loading or by the output being short circuited

Check the output terminals are not shorted. Remove the load. If the output voltage gets restored, the load is shorted or is offering large reactive impedance.

Unit is shut down due to over temp. (SEC-1223)

Check that the fan has not failed or the vent openings are not blocked

PROBLEM : Output voltage drops as soon as the load is switched on

PROBABLE CAUSE

SUGGESTED REMEDY

The unit is going into current limit protection mode



Reduce the load current to less than the current limit value. Motors, pumps, compressors, relays, incandescent and halogen lamps and large capacitors in the input section of the DC devices draw very high inrush or starting currents of up to 10 times their normal operating currents. Ensure that these inrush/starting currents are below the current limit value of the power supply.

TROUBLESHOOTING WHEN USING THE POWER SUPPLY WITH RADIO TRANSCEIVERS

- This power supply generates, uses and can radiate RF energy as per limits laid down under class “B”, Part 15 of FCC rules. Position the radio, antenna and the power supply to minimize any received spurious noise from the supply and excess RF energy from the transmitter. Ideally, for a 100W HF installation, the antenna should be at least 40 to 50 ft. from the power supply to eliminate the effect of transmitter energy on the power supply and the effect of the power supply on introducing noise into the receiver.
- If the supply fails to turn on, check that the transceiver is off. The supply may turn on with a lower load (Transceiver in receive mode) but may not turn on if the transceiver is in transmit (High current consumption) mode.
- A slowly moving buzzing carrier heard in the receiver may be caused by the antenna being too close to the equipment. A loose coaxial connector or a broken or missing ground may aggravate this problem. Normally, these noises will be below the background or “band” noise. RF feedback from transmitter may create instability in the power supply causing a poor sounding, raspy or unstable transmitted signal. A distance of 40 to 50 ft between antenna and equipment is generally recommended for any 100 Watt HF installation. Position the antenna as far and as high from the equipment as possible.
- The supply may turn off due to excessive transmitter energy being coupled into the AC and the DC lines. Either your antenna is too close (Less than 10 ft.) or the antenna system is not radiating properly. First check the antenna system SWR. Then, if necessary, relocate either the antenna or the equipment further apart.

SPECIFICATIONS

INPUT VOLTAGE	100 – 130 VAC, 60 HZ (PRE-SET) 200 – 260 VAC, 50 HZ (REQUIRES INTERNAL JUMPER SETTING)		
OUTPUT VOLTAGE	13.8 VDC		
OUTPUT RIPPLE & NOISE (ON FULL LOAD)	SEC-1212	LESS THAN 10 mV RMS	
	SEC-1223	LESS THAN 15 mV RMS	
OUPUT CURRENT, CONTINUOUS	SEC-1212	10 A	
	SEC-1223	23 A	
CURRENT LIMIT	SEC-1212	14 A	
	SEC-1223	25 A	
COOLING	SEC-1212	CONVECTION	
	SEC-1223	TEMPERATURE CONTROLLED FAN	
PROTECTIONS	OVER CURRENT, SHORT CIRCUIT AND OVER VOLTAGE (THROUGH PWM CONTROLLER). OVER TEMPERATURE SHUT DOWN FOR SEC-1223		
FUSE RATING	5 MM X 20 MM GLASS FUSE, 250 V		
		<u>120 VAC</u>	<u>240 VAC</u>
	SEC-1212	3 A	2 A
	SEC-1223	6.3 A	4 A
DIMENSIONS (W X D X H), INCHES	7.0 X 8.25 X 2.2		
WEIGHT	SEC-1212	3 LBS. NET	
	SEC-1223	3.5 LBS. NET	

SAFETY CERTIFICATION	<p>LISTED 6G18</p>  
	E179076

NOTE : SPECIFICATIONS ARE SUBJECT TO CHANGE WITHOUT NOTICE

3 YEAR Limited Warranty

SEC-1212/SEC-1223 manufactured by Samlex America, Inc. (the " Warrantor ") is warranted to be free from defects in workmanship and materials under normal use and service. This warranty is in effect for 3 years from the date of purchase by the user (the " Purchaser ")

In any case part of the equipment proves to be defective, the purchaser should do the following :

1. Prepare a written statement of the nature of the defect to the best of the Purchaser's knowledge, and include the date of purchase, the place of purchase, and the Purchaser's name, address and telephone number.
2. Call Samlex America, Inc. 1-800-561-5885 or 1 (604) 525-3836 and request a returning merchandise authorization number (RMA).
3. Return the defective part or unit along with the statement at the Purchaser's expense to the Warrantor ; Samlex America Inc., #110 - 17 Fawcett Road, Coquitlam, B.C. V3K 6V2 Canada. The RMA number must be marked clearly on the outside of the packaging.

If upon the Warrantor's examination the defect proves to be the result of defective material or workmanship, the equipment will be repaired or replaced at the Warrantor's option without charge, and returned to the Purchaser at the Warrantor's expense.

No refund of the purchase price will be granted to the Purchaser, unless the Warrantor is unable to remedy the defect after having a reasonable number of opportunities to do so.

Warranty service shall be performed only by the Warrantor. Any attempt to remedy the defect by anyone other than the Warrantor shall render this warranty void.

There shall be no warranty for defects or damages caused by faulty installation or hook-up, abuse or misuse of the equipment including exposure to excessive heat, salt or fresh water spray, or water immersion.

No other express warranty is hereby given and there are no warranties which extend beyond those described herein. This warranty is expressly in lieu of any other expressed or implied warranties, including any implied warranty of merchantability, fitness for the ordinary purposes for which such goods are used, or fitness for a particular purpose, or any other obligations on the part of the Warrantor or its employees and representatives.

There shall be no responsibility or liability whatsoever on the part of the Warrantor or its employees and representatives for injury to any persons, or damage to person or persons, or damage to property, or loss of income or profit, or any other consequential or resulting damage which may be claimed to have been incurred through the use or sale of the equipment, including any possible failure of malfunction of the equipment, or part thereof.

The Warrantor assumes no liability for incidental or consequential damages of any kind.

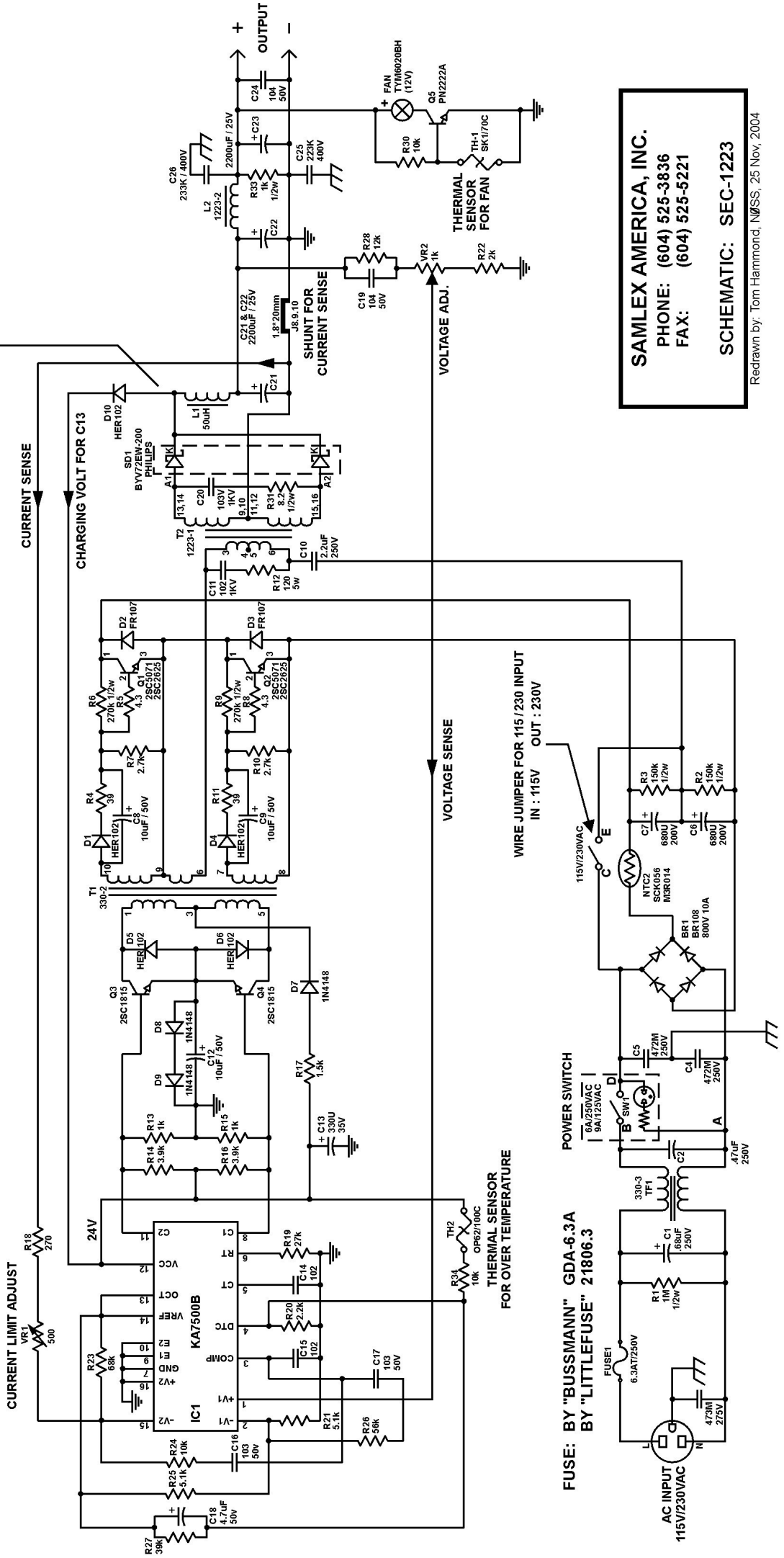
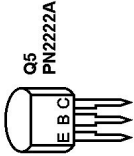
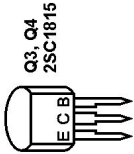
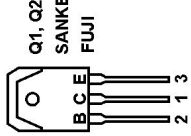
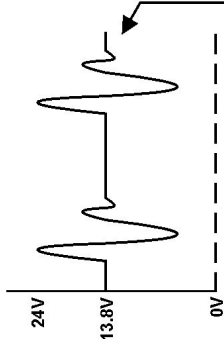
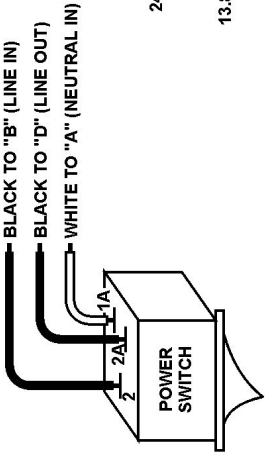
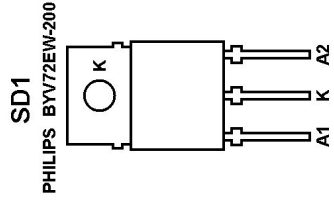

SAMLEX AMERICA, INC.
PHONE: (604) 525-3836
FAX: (604) 525-5221
SCHEMATIC: SEC-1223

Redrawn by: Tom Hammond, NPSS, 25 Nov, 2004



Thank you for purchasing a Samlex power supply product !

Samlex America Inc.
110 -17 Fawcett Road
Coquitlam, B.C. V3K 6V2
Canada

Ver.A(042001)